

V2 – 0416 RS PRO



Congratulations on your JRZ purchase!

Since our inception, JRZ Suspension Engineering has led the way in suspension design and development for the modern race, rally and high performance road car. JRZ systems offers the best solutions for each application in single, double, triple and quadruple adjustable dampers.

The JRZ Suspension damper is a race winning design, incorporating decades of experience in gas hydraulic damper and suspension design, applied to race cars ranging from F1, Indy cars, Grand Touring, Trans Am to all kinds of racing and other applications combined with a thorough knowledge of vehicle dynamics of modern race cars. Please read the following information about the right adjustment and correct maintenance of the shock absorbers before you drive your vehicle. Contact your dealer for further questions.

The JRZ dampers allow the driver and/or engineer to get the car tuned to their preference. Each adjustment makes a significant change in the damping characteristic. Every damper is tested and matched on the dyno prior to delivery. All JRZ dampers are made with the highest quality aerospace materials and manufactured to the highest standards.

Maintenance and adjustments

Contact your nearest authorized JRZ Suspension Engineering dealer as initial contact for all warranty and maintenance. Any service must be performed by authorized JRZ Suspension Engineering dealers.

Technological developments have complicated shock absorbers and the speed at which new developments make their appearance increases. It is impossible to provide all information that is needed for your damper to restore and maintain. To reduce the risks of injuries it is extremely important to perform maintenance and repairs by authorized JRZ Suspension Engineering dealers.

Do not modify your shock absorbers. Any modifications, use of non-authorized replacement parts or incorrectly performed maintenance voids warranty and may damage the damper. Moreover all these things could result in serious injuries to the driver.

Proper maintenance is crucial for optimum performance and life of the shock absorber. Please follow the service schedule recommended in this folder. If your dampers ever make any unusual noises or air or oil spills, stop driving immediately and get the dampers revised by your nearest authorized JRZ Suspension Engineering dealer.

NOTE: JRZ Suspension Engineering dampers are pressurized with Nitrogen. Do not open the part under pressure to clean or lubricate the air chamber. The part does not need to be opened except by an authorized JRZ Suspension Engineering dealer. Opening the part is dangerous and can cause serious injuries. Attempts to open the part voids warranty.



WARNING! Make sure you have read and understood the warnings, instructions and content of the manuals before using the vehicle.



WARNING! Do not modify the damper in any way. Do not sandblast the damper, do not drill holes in it, do not fill the damper and don't remove any part. Do not install non-compatible spring parts. Driving with a damaged, broken, deteriorated or poorly adapted frame or damper you may lose control of the vehicle with a crash as result.



WARNING! The repair of JRZ Suspension Engineering dampers requires special knowledge and tools. JRZ Suspension Engineering recommends that all service and repairs are performed by an authorized JRZ Suspension Engineering dealer.



Caution: Any changes made to your dampers means that your vehicle no longer satisfy our specifications and therefore void warranty.

Service schedule

Racing:

6 races
Or after 24h endurance race

Regular street use:

Every 20 000 km



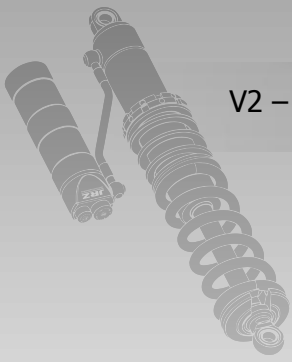

V2 – 0416 RS PRO



JRZ Suspension Engineering B.V.
Rietdekkerstraat 3
5405 AX Uden Phone + 31 413 259 100
The Netherlands Fax + 31 413 259 770

E-mail info@JRZsuspension.com
VAT nr. NL807463814B01
CoC No. 16078563

Rabobank 171521102
IBAN/SEPA No. NL94RABO0171521102
BIC/SWIFT No. RABONL2U



All our quotations, all orders to us and in all our agreements are appropriate. METAALUNIE CONDITIONS filed at the Registry of the District Court in Rotterdam as they read the text as set out therein. The conditions are available on request.

www.JRZsuspension.com

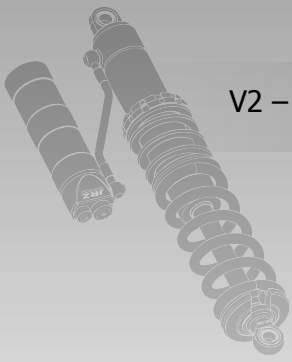

V2 – 0416 RS PRO



JRZ Suspension Engineering

Installation instructions



**Before you begin the installation,
please read the following manual carefully.**

- **Check the package for shipping damage.** If damaged then please take the following steps: 1. Stop unpacking, take pictures before proceeding unpacking; 2. unpack the box and check for damaged parts; 3. Take pictures of the damaged parts; 4. contact your JRZ dealer or contact the JRZ factory thru the website www.jrzuspension.com
- **Check the content of the package with the packing list that is provided with the package.**
- **Check the shock identification numbers (silver sticker), they should match the numbers on the packing list.**

JRZ suspension parts are engineered, produced and assembled with the highest quality. Therefore these parts should be easy to install. However it is always possible that there are complications while installing. In that case please contact your JRZ dealer or contact the JRZ factory thru the website www.jrzuspension.com.

All suspension parts need to be installed and removed according to the manufacturer's specifications for installing and removing the standard springs and damper components, unless otherwise specified in this installation manual.

www.JRZuspension.com

JRZ Suspension Engineering B.V.
Rietdekkerstraat 3
5405 AX Uden
The Netherlands
Phone + 31 413 259 100
Fax + 31 413 259 770

E-mail info@JRZuspension.com
VAT nr. NL807463814B01
CoC No. 16078563

Rabobank 171521102
IBAN/SEPA No. NL94RABO0171521102
BIC/SWIFT No. RABONL2U



All our quotations, all orders to us and in all our agreements are appropriate. METAALUNIE CONDITIONS filed at the Registry of the District Court in Rotterdam as they read the text as set out therein. The conditions are available on request.

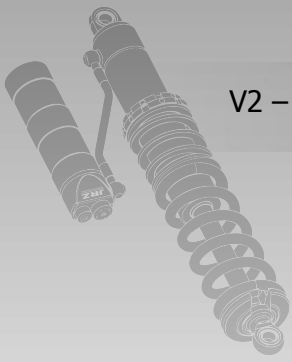

V2 – 0416 RS PRO



Warning

Always follow the latest accident prevention regulations (not applicable for North America) for each step to prevent any serious bodily harm or injury.

1. We recommend the use of a vehicle hoist or lift when installing the suspension. If a lift is not available and jacking equipment is used, make sure that the vehicle is secured with commercial wheel blocks and jack stands to ensure safety.
2. The suspension components may only be installed by trained technical personnel using the proper tools.
3. The general instructions for use must be read before attempting to install the suspension.
4. Never disassemble or cut open the shock absorbers. They contain oil under pressure. Danger of explosion.
5. If the vehicle is equipped with OEM electronic dampers, the OEM electronic suspension control needs to be disabled through an authorized dealer.
6. Please take care that in any case fittings (for example fitting of the shock absorber to the wheel hub or control arm) are free of dirt and oil when installing the suspension.

General instructions for use

1. Only adjust the vehicle height when the wheels are in full droop.
2. When adjusting the vehicle height, make sure that threads are clean and free of debris. After initial cleaning, move the spring perches a significant amount downward so that you can clean the threads that were covered by the perch. For easy adjustment, a lubricant may be used penetration oil or anti seize grease. In a aluminum application do not use a copper seize grease. Make sure you clean the complete shock absorber after installation.
3. If possible, for example in a non coil-over application, remove the height adjustment from the vehicle to adjust the height.
4. In any case, after adjusting the vehicle height, carry out the work in the general installation instructions, step 11 to 14.
5. When adjusting the shock absorbers make sure not to over tighten the knobs to the end position.
6. In case of a external reservoir make sure the hoses are free, use tie-wraps if necessary.
7. In case of a insert shock absorber make sure the insert part is free from rust and debris.
8. In case of a insert shock absorber use a chisel to carefully widen the hub, make sure that you don't hit the damper with the chisel.

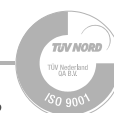

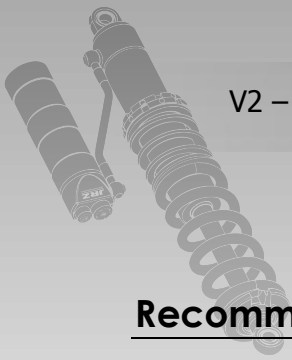

V2 – 0416 RS PRO



Recommended torque specifications

Always follow the manufacturers torque specifications when installing the suspension components!

Guideline tightening torque *[NOT FOR JRZ TOPMOUNT]*

	Bolt grade		
Bolt diameter	8.8 [Nm (ft-lb)]	10.9 [Nm (ft-lb)]	12.9 [Nm (ft-lb)]
M6	10,3 (7,6)	14,7 (10,8)	17,6 (12,9)
M8	25,5 (18,8)	35,3 (26,0)	42,1 (31,0)
M10	50,0 (36,8)	70,6 (52,0)	85,3 (62,9)
M12	87,2 (64,3)	122,6 (90,4)	147,1 (108,5)
M14	138,3 (102,0)	194,2 (143,2)	235,4 (173,6)
M16	210,8 (155,4)	299,1 (220,6)	357,9 (263,9)

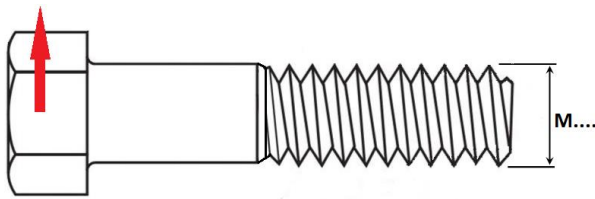

M=metric and the following number is the thread diameter in mm. Thus M5 has a 5mm diameter thread (not the diameter of spanner you need). These tightening torques are guidelines for metric screws according to DIN ISO 261. A frictional torque of 0,14 has been used, when screws are lubricated with anti seize grease the tightening torque should be lowered with 20%.

Tightening torques for the JRZ piston rod nut:

- Never use pliers on the piston rod.
- Using an impact wrench is on own risk.
- When using an impact wrench only use the lowest force level.
- Only torque the nut for a short period of time.
- Never torque two nuts at the same time.
- When this guidelines are not followed failure of the pintop may occur.



Nut	Torque (Nm)	Torque (ft-lb)
M10x1	20	15
M12x1,25	35	26
M14x1,5	50	37



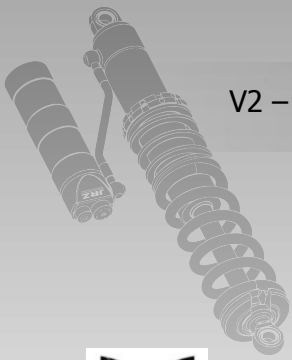

V2 – 0416 RS PRO



General installation instructions

JRZ suspension is **not** responsible for faults or defects that may occur in the shock absorber due to faulty installation. You must install the suspension as described in this general installation instruction.

1. Before installation, the vehicle should be rolled onto level ground. Once on level ground, measure the vehicle ride height and note these values in the table below. The easiest way to measure the ride height is from center wheel to the wheel arch as shown in the picture.

	Left	right
Front		
Rear		



2. We recommend the use of a vehicle hoist or lift when installing the suspension.
3. Warning: If the vehicle is equipped with ride height sensors, they should be removed before removal of the shock absorbers, otherwise damage to the sensors can occur.
4. The suspension parts should be removed as specified in the manufacturers instructions.
5. Manufacturer recommended tools for removal of the original suspension parts, or a commercial spring compressor, must be used in order to remove the factory mounted suspension systems.
6. It is imperative that you do not damage the piston rod surface during installation through the use of pliers, etc. The smallest damage on the piston rod surface will result in seal damage. An impact torque wrench, set to the correct torque, may be used.
7. Install the spring hardware, springs, top mounts and/or spring adaptors. Make sure that the spring perches of both front shock absorbers and both rear shock absorbers are set to the same height.
8. Ensure that the spring perch bolt is tightened to prevent movement of the spring perch. The spring perch bolt tightening torque is 8Nm (5.9 ft-lb).
9. Install the suspension parts on the vehicle as specified by the vehicle manufacturer.
10. All torque values must comply with vehicle manufacturer recommended specifications

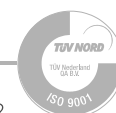

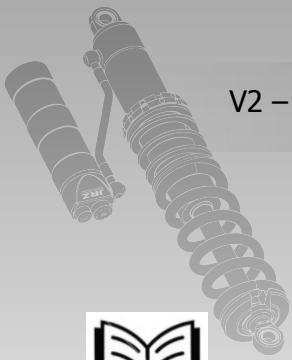

General installation instructions (continued)

11. After assembly and installation is complete, the vehicle should be rolled onto level ground. Once on level ground, measure the vehicle ride height and note these values in the table below. It is best to roll the car a significant distance as the suspension needs to settle. This settling is normal and can be as much as 10mm. After settling of the suspension, adjust the spring perches to get the desired ride height.

	Left	right
Front		
Rear		

12. **Important:** Examine the clearance between the tires and the suspension over the full range of motion of the wheel! The minimum clearance between the suspension and the tire is about 4mm (0.16 inches). If this clearance is less than 5mm (0.2 inches), wheel spacers may be necessary. Make sure there is sufficient clearance between all suspension parts. To be sure, finally, test drive the car and check afterwards for clearance issues. If there are clearance issues, which are not spotted by the installer through these general installation instructions, JRZ suspension is not responsible for damage that occurred due to clearance issues. (remark: it's always best, when checking for clearance, to also check the stroke of the damper)
13. The geometry of the suspension needs to be adjusted according to the regulations of the vehicle manufacturer. If a value can not be reached due to the difference in ride height, an optimal value within the vehicle manufacturer's tolerance range should be set. Make sure this is a logical chosen value and are both the same for left and right.
14. All components that are affected by the change in vehicle ride height (for example: headlights, etc.) must be updated as specified in the vehicle manufacturer instructions due to the changed ride height of the vehicle.

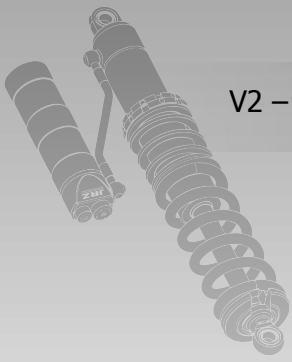

V2 – 0416 RS PRO



JRZ RS PRO

Double adjustable mono tube damper

- Adjustable Compression damping.
15 clicks
- Ride height adjustable
- Adjustable Rebound damping
24 clicks
- Do not loosen dust covers.
- Do not use pliers on piston rod.
- Do not use short sockets to tighten pin tops.
- Do not loosen filling plug or drill in the damper body.
- Never dismount the compression knob, this disrupts the compression setting.

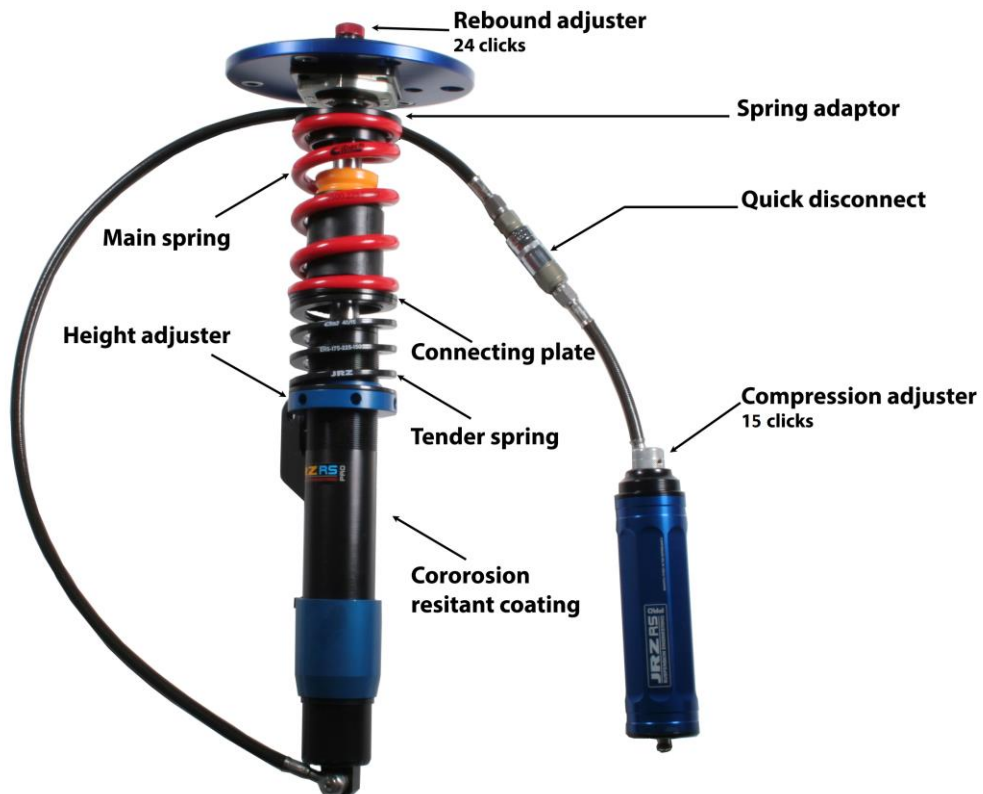

www.JRZsuspension.com

JRZ Suspension Engineering B.V.

Rietdekkerstraat 3
5405 AX Uden Phone + 31 413 259 100
The Netherlands Fax + 31 413 259 770

E-mail info@JRZsuspension.com
VAT nr. NL807463814B01
CoC No. 16078563

Rabobank 171521102
IBAN/SEPA No. NL94RABO0171521102
BIC/SWIFT No. RABONL2U

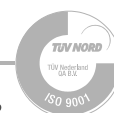

All our quotations, all orders to us and in all our agreements are appropriate. METAALUNIE CONDITIONS filed at the Registry of the District Court in Rotterdam as they read the text as set out therein. The conditions are available on request.

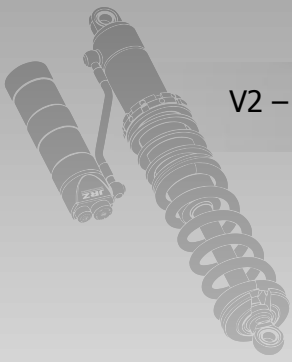

V2 – 0416 RS PRO



Damping adjustment knob in eyelet use adjustment tool (included in set).



Height adjustment

- Only adjust the height adjuster while wheels are off the ground and damper is in droop.
- Make sure the set screw in height adjuster has been loosed.
- After adjusting the height adjuster make sure to tighten the set screw in the height adjuster with 8 ft.lb (10 Nm).
- The main and tender spring should always be on preload when the car is in droop.
- A anti seize lubricant may be used (WD-40 etc.) in case of an aluminum damper body do not use copper grease.



**Setscrew 10 [Nm]
or 8 [ft.lb]**

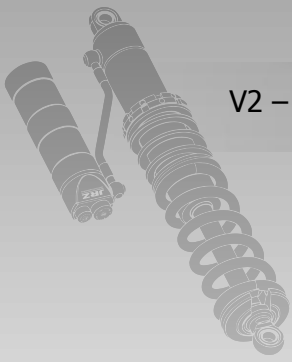

V2 – 0416 RS PRO



Using the quick disconnect

Disconnecting the reservoir

1. Before disconnecting the reservoir, make sure the dampers are completely unloaded.

When dampers are mounted on the vehicle than the vehicle has to be on jack stand and the anti roll bar has to be disconnected, so that the wheels are in full droop.

2. Take off the gas pressure by blowing of the schraeder valves. Make sure that all the gas pressure is blown off.
3. Take off the reservoir, never use dampers with disconnected reservoirs. By doing so you could damage the dampers internals.

Connecting the reservoir

4. Connect the reservoir.
5. With the damper in full droop, put a gas pressure of 17 bar (250 PSI) on the system. This should be nitrogen.
6. The damper is now ready for use!



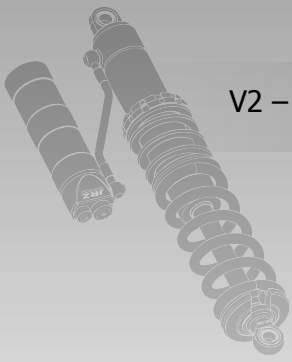

V2 – 0416 RS PRO



Shock absorber gas pressure

When using the JRZ RS pro suspension or a JRZ race-line suspension, the gas pressure is adjustable. Always use the JRZ pressure gauge (89-13-00-00) to adjust the gas pressure. From the factory the gas pressure is set at 250psi. The recommended gas pressure range is: **150psi (10bar) to 350psi (24bar).**



Do not adjust the gas pressure out of the recommended gas pressure range!

If the recommended gas pressure is not followed, JRZ suspension is **not** responsible for faults or defects that may occur in the shock absorber.

The gas pressure in the shock absorber results in an added lifting force. The higher the gas pressure, the higher the lifting force. The lifting force can be calculated with the following formula:

$$F = P \times (0,25 \times \pi \times d^2)$$

F = lifting force in kg

P = pressure inside the reservoir in bar

d = diameter of the pistonrod in cm

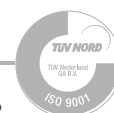
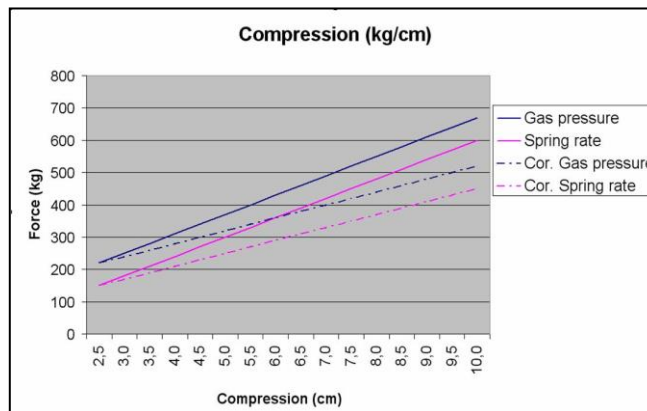

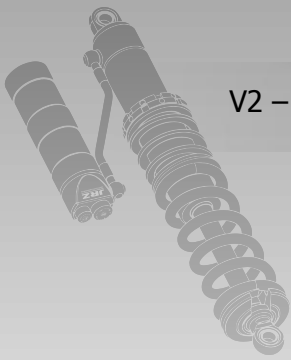

V2 – 0416 RS PRO



Installation

- When installing a JRZ RS PRO be careful not to hit the rebound/compression adjuster /threaded area for this is a fragile part of the damper.
- Never use pliers on the piston rod, doing so will cause damage to the piston rod and may cause leakage of the damper.
- After installing the dampers make sure the car is aligned.

Basic adjustments and factory settings

Rebound adjustment

- Rebound adjustment is located at the top of the piston rod. Factory setting is 5 clicks from full soft.
- Do not force adjustment knob in full hard or full soft
- Adjustment clockwise makes the damping softer, counter clockwise makes the damping harder.
- Zero point is first detent from the stop in full soft.
- Total clicks 24.
- Change 1 click at a time.

Compression adjustment

- Compression adjustment is located on the top of the reservoir. Factory setting is 5 clicks from full soft.
- Do not force adjustment knob in full hard or full soft
- Adjustment clockwise makes the damping softer, counter clockwise makes the damping harder.
- Zero is first detent from the stop.
- Total clicks 15
- Change 1 click at a time.

Factory setting

- Factory setting is +3 compression and +6 rebound clicks from full soft for road use.
- Start out with +6 compression and +10 rebound clicks from full soft for track.

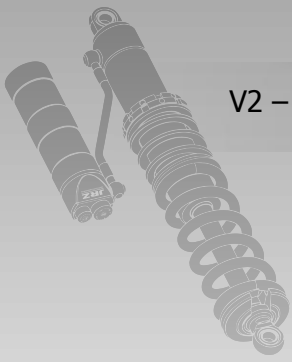

V2 – 0416 RS PRO



Adjusting damping force

At JRZ we use a Roehrig shock dyno to test and tune every damper we build. By doing so we know that every damper we sent out is working like we intent it to. Below you see a Force – displacement graph produced by a JRZ RS PRO on a Roehrig shock dyno. The Force in Newton is displayed on the vertical axis, the displacement in inches is displayed on the horizontal axis.

In the force / displacement graph below you can see what happens when you adjust the compression adjuster knob. During the compression stroke the piston rod is pushed in the damper body (top side of the graph). With every compression click (counter clock wise) you increase the compression damping force. By increasing the compression damping the force needed to compress the damper is higher.

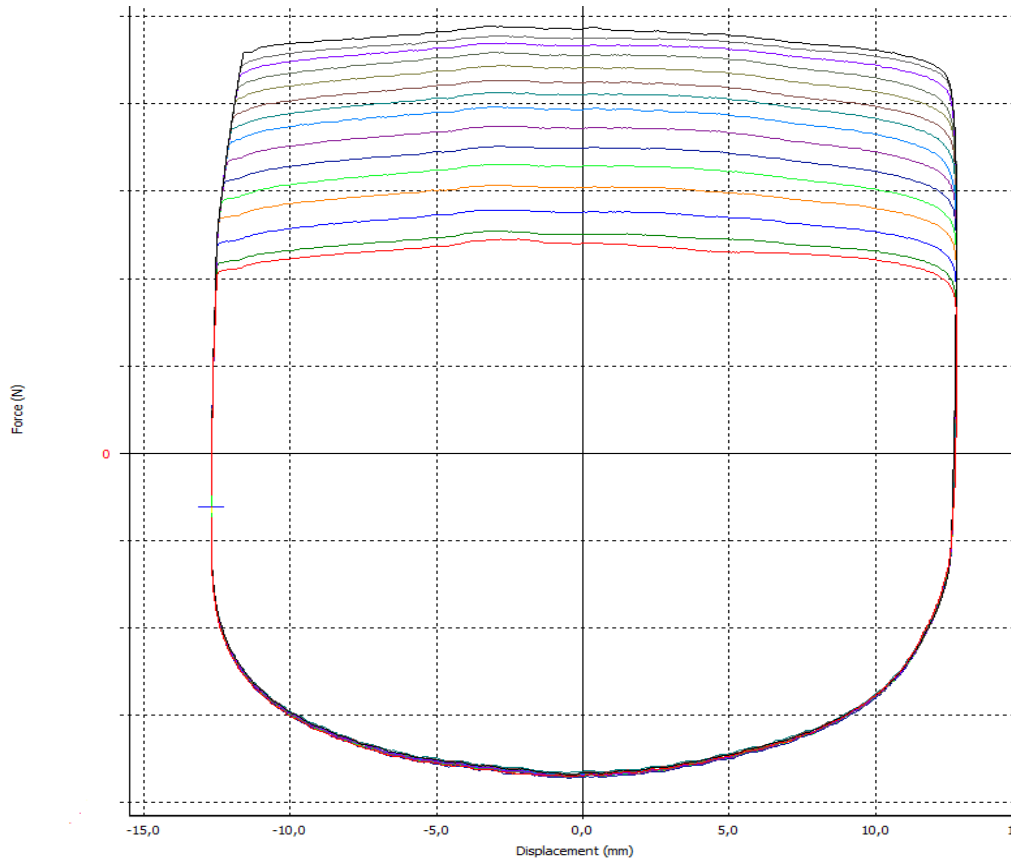

Compression damping JRZ RS PRO graph

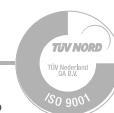

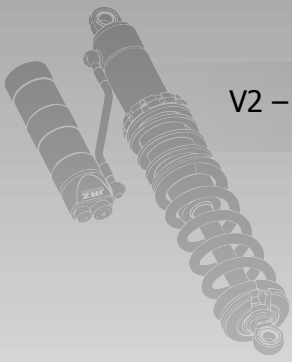

V2 – 0416 RS PRO



In the force / displacement graph below you can see what happens when you adjust the rebound adjuster knob. During the rebound stroke the piston rod moves out of the damper body (bottom side of graph). With every rebound click (counter clock wise) you increase the rebound (and slightly compression) damping force. By increasing the rebound damping the force needed to extend the damper increases.

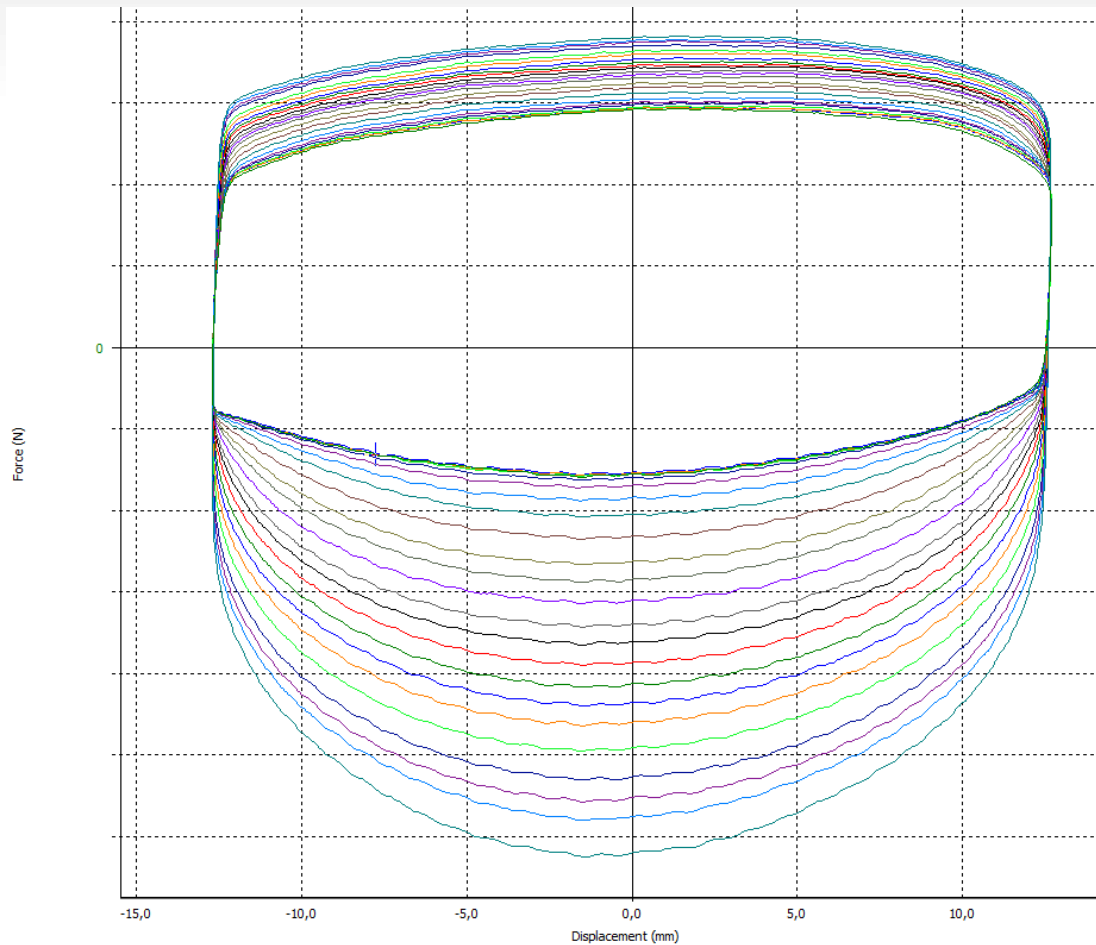

Rebound damping JRZ RS PRO graph

With your JRZ SUSPENSION every click will be noticeable and have direct influence on the handling of the car. Therefore it is suggested that you only adjust one click at a time when adjusting the dampers.



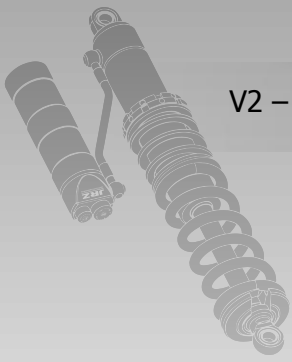

V2 – 0416 RS PRO



Exploded view

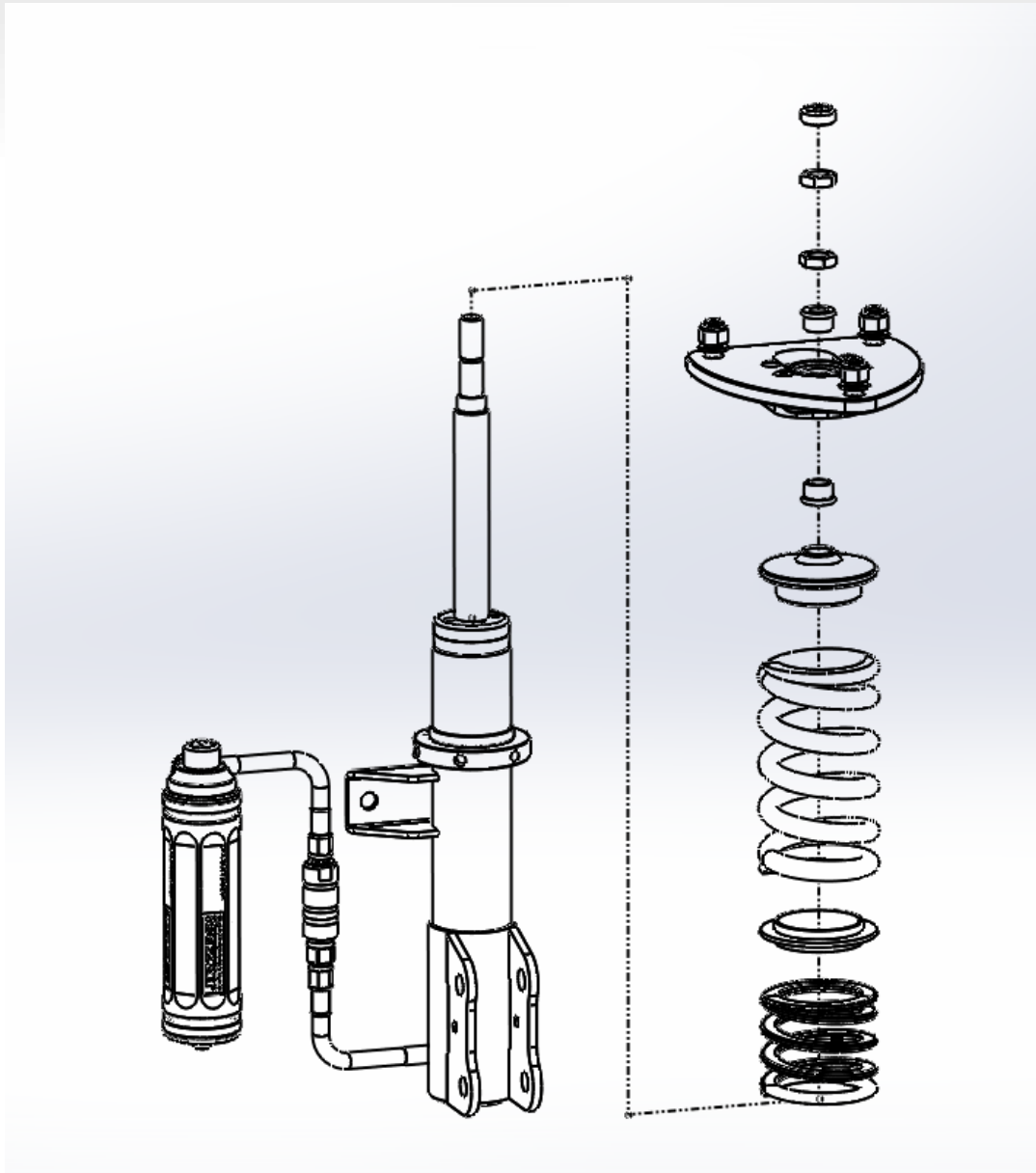

The information in this publication was compiled with the greatest care; nevertheless, no rights may be derived from this publication. All rights reserved, copyright by JRZ.

